



Alfa Laval Unique 7000 Series - Tank Outlet Valve

Simply Unique

Concept

The Unique 7000 Series is an innovative new generation of Tri-Clover® single seat valves that are designed to meet the highest process demands of hygiene and safety. They're built on a well-proven, platform from an installed base of more than one million valves.

Working principle

The valve is remote-controlled by means of compressed air. It has few and simple moveable parts which results in a very reliable valve and low maintenance cost.

Standard design

The Unique 7000 Tank Outlet valve is designed to deliver years of reliability and performance you've come to expect with all Tri-Clover® products. Its flexible design consists of a valve body, seat and tank flange that are clamped together. The TR2 seat ring with enhanced CIP capabilities and hygiene comes standard with all Unique 7000 series valves. For added confidence, the valve can be supplied with a controlled compression elastomer seat ring. The standard actuator comes with a five year warranty. The Unique 7000 Tank Outlet valve sizes range from 2" to 4".

The body can be turned in any position if the clamps are slightly loosened. The tank flange is welded directly into the tank. (Important! Observe welding guideline in instruction manual) The tank flange is supplied with TÜV approval AD 2000 and inspection certificate 3.1 according to EN10204.

TECHNICAL DATA

Temperature

Max. product pressure in tank: 145 psi (1000 kPa (10 bar)) - max. 68° F
..... 123 psi (850 kPa (8.5 bar)) - max 212° F
..... 109 psi (750 kPa (7.5 bar)) - 302° F
Temperature range: 14°F to +284°F (EPDM)

Pressure

Max. product pressure in pipeline (depends on valve specifications): 145 PSI (10 bar)
Max. product pressure in tank (depends on valve specifications and temperature): 145 psi (10 bar) - max. 68° F
..... 123 psi (8.5 bar) - max 212° F
..... 109 psi (7.5 bar) - 302° F
Min. product pressure: Full vacuum
Air pressure: 72.5 to 101.5 PSI (5 to 7 bar)



Valve Body Combinations

Valve Body Combinations



001



002

TD 467-514

Options

- A. Weld ends or connection types other than Tri-Clamp
- B. Control and Indication: IndiTop, ThinkTop or ThinkTop Basic.
- C. Aseptic version
- D. Product wetted seals in HNBR or FPM.
- E. Replaceable elastomer plug seals
- F. Manually operated
- G. NO or A/A actuator
- H. High pressure actuator.
- I. Long stroke actuator
- J. Maintainable actuator.
- K. External surface finish bright.

Other valves in the same basic design

The valve range includes several purpose built valves. Below are some of the valve models available, though please use the Alfa Laval computer aided selection tool (Anytime configurator) for full access to all models and options.

- Single Seat valve.
- Reverse acting valve.
- Long stroke valve.
- Manually operated valve.
- Aseptic valve.

Note!

For further details, see instruction ESE00364.

Dimensions

Size	2"	2½"	3"	4"
A1	16.79	17.28	18.84	19.81
A2	15.49	15.98	17.5	18.51
A3	14.50	15.00	16.36	17.33
A4	15.37	15.86	17.42	18.39
A5	14.35	14.84	16.20	17.17
C	1.18	1.2	1.18	1.18
OD	2.01	2.5	3.0	4
ID	1.88	2.37	2.87	3.84
t	0.06	0.06	0.06	0.08
E	2.40	3.19	3.39	4.69
E1	2.63	2.88	3.13	3.61
F1	0.98	0.98	1.18	1.18
F2	1.02	1.02	1.22	1.22
H	4.52	4.52	6.07	6.07
J	5.83	6.42	7.01	7.80
S	0.61	0.61	0.81	0.81
M/ Clamp	0.50	0.50	0.50	0.63

Weight (lb)				
Standard	7.1	8.3	13.3	15.9
Reverse Acting	7.2	8.4	13.5	16.1

A1= min. Installation measure to allow that valve can be lifted out of the tank flange / valve body (if Indication Unit is mounted, height must be added)

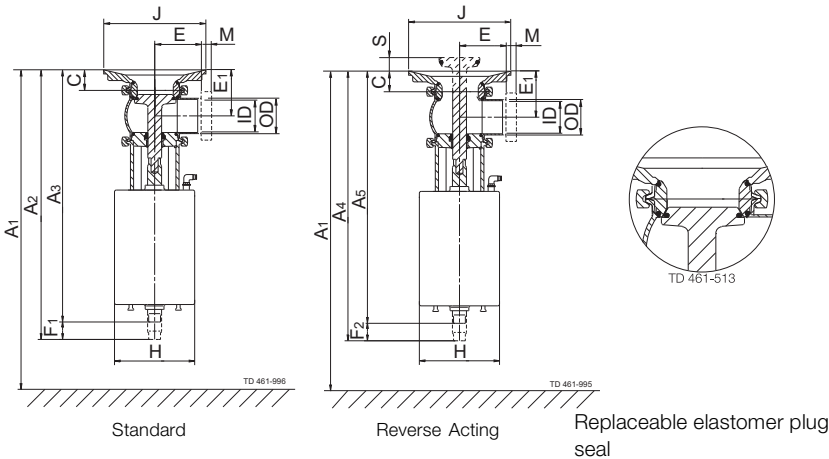

Please note!

Opening/closing time will be affected by the following:

- The air supply (air pressure).
- The length and dimensions of the air hoses.
- Number of valves connected to the same air hose.
- Use of single solenoid valve for serial connected air actuator functions.
- Product pressure.

Air Connections Compressed air:

R 1/8" (BSP), internal thread.

Actuator function

Air consumption (ln ³ free air) for one stroke	
2" - 2½"	3" - 4"
2.17 x air pressure [psi]	5.51 x air pressure [psi]

Pressure drop/capacity diagrams

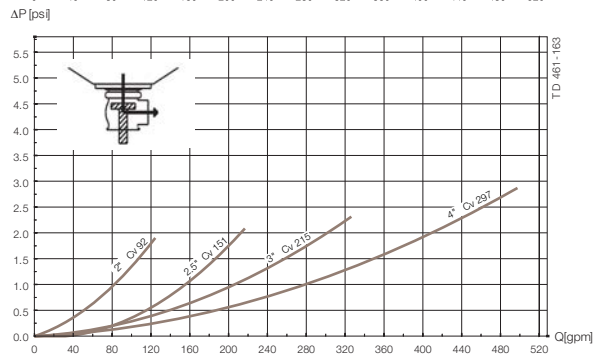
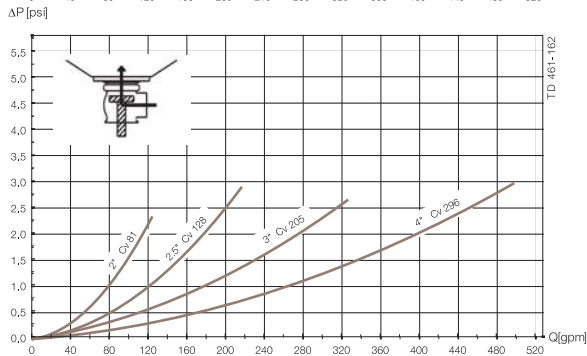
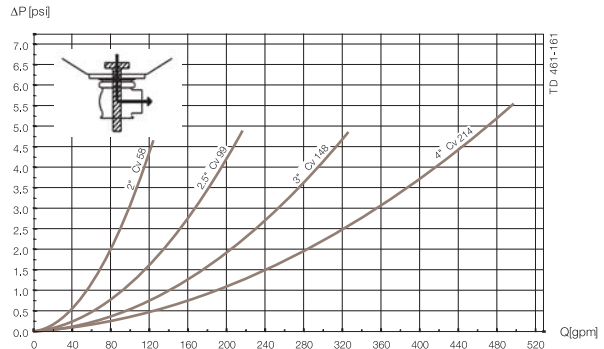
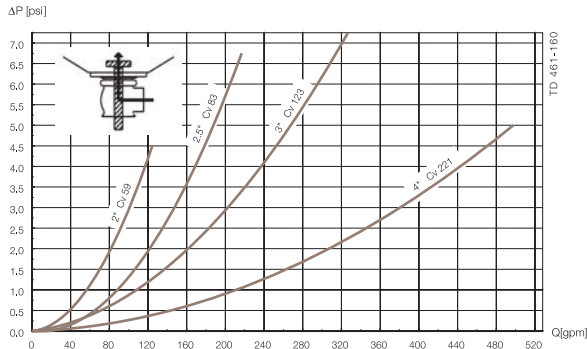

Note!

For the diagrams the following applies:
Medium: Water (68° F/20°C)

Measurement: In accordance with VDI2173

Pressure drop can also be calculated in Anytime configurator.

Pressure drop can also be calculated with the following formula:

$$Q = Cv \times \sqrt{\Delta p}$$

Where

Q = Flow (gallon/minute).

Cv = gallon/minute at a pressure drop of 1 psi (see table above).

Δp = Pressure drop in psi over the valve.

Where

Q = Flow (gallon/minute).

Cv = gallon/minute at a pressure drop of 1 psi (see table above).

Δp = Pressure drop in psi over the valve.

2.5" shut-off valve, where Cv = 128 (See table above).

$$Q = Kv \times \sqrt{\Delta p}$$

$$160 = 128 \times \sqrt{\Delta p}$$

$$\Delta p = \left(\frac{160}{128}\right)^2 = 1,6 \text{ psi}$$

(This is approx. the same pressure drop by reading the y-axis above)

Pressure data for Unique 7000 Series Tank Outlet Valve

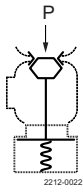

1

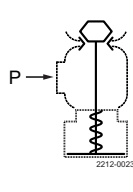

2

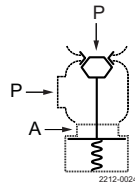

3

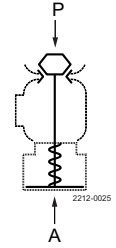

4

A = Air

P= Product pressure

**Table 1 - Shut fully closed
Actuator / Valve body
combination and direction
of pressure**

**Max. pressure in PSI without leakage at the valve seat
Valve size**

	2"	2½"	3"	4"
1	104	61	93	61
2	122	65	99	64

Table 2

**Actuator / Valve body
combination and direction
of pressure**

**Air
pressure
(PSI)**

**Max. pressure in PSI against which the valve can open
Valve size**

	2"	2½"	3"	4"
3	145	131	145	100
4	145	121	144	96

Alfa Laval reserves the right to change specifications without prior notification.

How to contact Alfa Laval

Contact details for all countries are continually updated on our website. Please visit www.alfalaval.us to access the information direct.